

**OWNER'S/
OPERATOR'S
MANUAL**

MODEL NO.'s

RMB-325

RMB-326

RMB-327

RMB-328

⚠ CAUTION

For Safe Operation
Read Rules And
Instructions Carefully

SINO LEEINGLES, PIDA AYUDA
A AIGUIEN QUE SI LO LEA
PARA QUE LE TRADUZCA LAS
MEDIDAS DE SEGURIDAD.

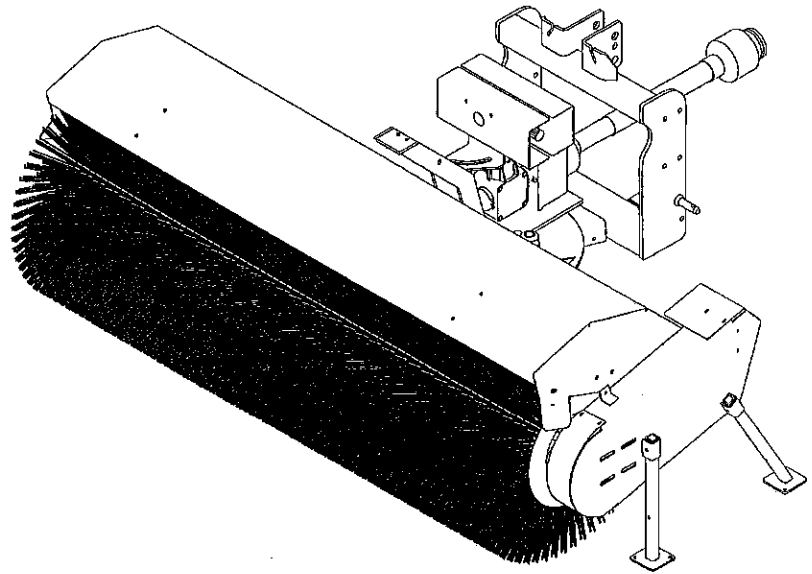

**3-PT. MOUNTED
PTO DRIVEN
ROTARY BROOM**

Safety Instructions

Tractor Preparation

Operating Instructions

Assembly & Mounting

Maintenance

Repair Parts

⚠ CAUTION ⚠

**THE FOLLOWING SAFETY PRECAUTIONS SHOULD BE THOROUGHLY UNDERSTOOD
BEFORE ATTEMPTING TO BEGIN ASSEMBLING THIS MACHINE**

1. Select an area for assembly that is clean and free of any debris which might cause persons working on the assembly to trip.
2. Do not lift heavy parts or assemblies. Use crane, jack, tackle, fork trucks or other mechanical devices.
3. Preview the assembly instructions in your operator's manual before proceeding further.
4. If the assembly instructions call for parts or assemblies to be blocked up, use only blocking material that is in good condition and is capable of handling the weight of the assembly to be blocked. Also insure that the blocking material is on a clean, dry surface.
5. Never put hands, or any part of body, under blocked up assemblies if at all possible.
6. After completing assembly, thoroughly inspect the machine to be sure that all nuts, bolts, hydraulic fittings or any other fastened assemblies have been thoroughly tightened.
7. Before operating the machine, thoroughly read the operation section of your operator's manual.
8. Before operating, read the maintenance section of your operator's manual to be sure that any parts requiring lubrication, such as gearboxes, are full, to avoid any possible damage.
9. **Before operating equipment – If you have any questions regarding the proper assembly or operation, contact your dealer or representative.**

TABLE OF CONTENTS

| | |
|--------------------------------|-------|
| WARRANTY | 2 |
| SPECIFICATIONS | 3 |
| CHECK LISTS | 4 |
| SAFETY INFORMATION | 5-13 |
| SAFETY SIGNS | 14-15 |
| PREPARATION INSTRUCTIONS | 16 |
| ASSEMBLY/INSTALLATION | 17-23 |
| ADJUSTING FOR WORK | 24-25 |
| OPERATING INSTRUCTIONS | 26-28 |
| SERVICE & MAINTENANCE | 29-34 |
| TROUBLE-SHOOTING GUIDE | 35-36 |
| PARTS LISTS | 37-42 |
| OPTION PARTS LISTS | 43-49 |

SINO LEEINGLES, PIDA AYUDA A
ALGUIEN QUE SI LO LEA PARA QUE
LE TRADUZCA LAS MEDIDAS DE
SEGURIDAD.

STATEMENT OF POLICY

It is the policy of Worksaver, Inc. to improve its products where it is possible and practical to do so. Worksaver, Inc. reserves the right to make changes or improvements in design and construction at any time, without incurring the obligation to make these changes on previously manufactured units.

TO THE OWNER:

Read this manual before using your 3 pt. Mounted Rotary Broom. This manual is provided to give you the necessary operating and maintenance instructions for keeping your rotary broom in top operating condition. Please read this manual thoroughly. Understand what each control is for and how to use it. Observe all safety signs on the machine and noted throughout the manual for safe operation of implement. Keep this manual handy for ready reference.

Like all mechanical products, it will require cleaning and upkeep. Lubricate the Broom as specified.

Use only genuine Worksaver service parts. Substitute parts will void the warranty and may not meet standards required for safe and satisfactory operation. Record the model and serial number of your Broom here:

Model: _____ Serial Number: _____

RETAIL CUSTOMER'S RESPONSIBILITY

It is the Retail Customer and/or Operator's responsibility to read the Operator's Manual, to operate, lubricate, maintain, and store the product in accordance with all instructions and safety procedures. Failure of the operator to read the Operator's Manual is a misuse of this equipment.

It is the Retail Customer and/or Operator's responsibility to inspect the product and to have any part(s) repaired or replaced when continued operation would cause damage or excessive wear to other parts or cause a safety hazard.

It is the Retail Customer's responsibility to deliver the product to the authorized Worksaver Dealer, from whom he purchased it, for service or replacement of defective parts which are covered by warranty. Repairs to be submitted for warranty consideration must be made within forty-five (45) days of failure.

It is the Retail Customer's responsibility for any cost incurred by the Dealer for traveling to or hauling of the product for the purpose of performing a warranty obligation or inspection.

LIMITED WARRANTY



Worksaver warrants to the original purchaser of any new 3 pt. mounted, PTO driven, Rotary Broom (Models RMB-325, RMB-326, RMB-327, RMB-328), that the equipment be free from defects in material and workmanship for a period of one (1) year for non-commercial, state, and municipalities' use ninety (90) days for commercial use from date of retail sale.

Replacement or repair parts installed in the equipment covered by this warranty are warranted for ninety (90) days from the date of purchase of such part or to the expiration of the applicable new equipment warranty period, whichever occurs later.

Such parts shall be provided at no cost to the user during regular working hours. Worksaver reserves the right to inspect any equipment or parts which are claimed to have been defective in material or workmanship.

DISCLAIMER OF IMPLIED WARRANTIES & CONSEQUENTIAL DAMAGES

Worksaver's obligation under this warranty, to the extent allowed by law, is in lieu of all warranties, implied or expressed, including implied warranties of merchantability and fitness for a particular purpose and any liability for incidental and consequential damages with respect to the sale or use of the items warranted. Such incidental and consequential damages shall include but not be limited to: transportation charges other than normal freight charges; cost of installation other than cost approved by Worksaver; duty; taxes; charges for normal service or adjustments; loss of crops or any other loss of income; rental of substitute equipment, expenses due to loss, damage, detention or delay in the delivery of equipment or parts resulting from acts beyond the control of Worksaver.

THIS WARRANTY SHALL NOT APPLY:

1. To vendor items which carry their own warranties, such as hydraulic cylinders and hydraulic motor.
2. If the unit has been subjected to misapplication, abuse, misuse, negligence, fire or other accident.
3. If parts not made or supplied by Worksaver have been used in connection with the unit, if, in sole judgement of Worksaver such use affects its performance, stability, or reliability.
4. If the unit has been altered or repaired outside of an authorized Worksaver dealership in a manner which, in the sole judgement of Worksaver affects its performance, stability or reliability.
5. To normal maintenance service and normal replacement items such as gearbox lubricant, hydraulic fluid, worn blades, or to normal deterioration of such things as belts and exterior finish, due to use or exposure.
6. To expendable or wear items such as teeth, chains, sprockets, brush segments, springs and other items that in the company's sole judgement is a wear item.

NO EMPLOYEE OR REPRESENTATIVE OF WORKSAVER IS AUTHORIZED TO CHANGE THIS WARRANTY IN ANY WAY OR GRANT ANY OTHER WARRANTY UNLESS SUCH CHANGE IS MADE IN WRITING AND SIGNED BY WORKSAVER'S SERVICE MANAGER, POST OFFICE BOX 100, LITCHFIELD, ILLINOIS 62056-0100.



3 PT. MECHANICAL DRIVE BROOM SPECIFICATIONS

| MODEL: | RMB-325 | RMB-326 | RMB-328 | RMB-328 |
|-------------------|------------------------------------------------------------------------------------------------------------------------------------------------|---------|---------|---------|
| Width | 60" | 72" | 84" | 96" |
| Path at 30° Angle | 52" | 64" | 76" | 88" |
| Brush Diameter | 32 inches | | | |
| Brush Material | Convuluted Polypropylene or Crimped Wire or 50/50 | | | |
| Brush Speed | Up to 130 rpm | | | |
| Lift | Tractor 3 pt. Hitch | | | |
| 3 pt. Hitch | Category I – 7/8" Hitch Pins (Cat. II Pins Opt.) | | | |
| Power | Tractor Rear 540 rpm PTO | | | |
| PTO Driveline | Telescoping Series II – 1 3/8" - 6 Spline Quick Coupling | | | |
| Gearbox | H.D. Double with 1:1 Ratio (Reversible) | | | |
| Cross Driveline | Telescoping Series II | | | |
| Chain Drive | #60 Roller Chain | | | |
| Brush Bearings | 1 1/4" H.D. Flange (Greaseable) | | | |
| Floatation | Broom Floats on Adjustable Spring/Chain Assembly | | | |
| Mechanical Angle | Straight, 15° Right/Left or 30° Right/Left | | | |
| Brush Hood | 16 Gauge Steel with formed 10 Gauge ends | | | |
| Parking Stands | Standard | | | |
| Weight | 655 lb. | 740 lb. | 840 lb. | 945 lb. |
| BROOM INCLUDES: | Welded Steel Frame, Steel Hood, Chain Shield, Height Adjustment Chains, Lower Hitch Pins, Parking Stands | | | |
| OPTIONS: | Mechanical Swing Lock, Hydraulic Swing Kit, Dirt Deflector - 3 pt., Dirt Deflector - Main Frame, Springler System, Sight Indicators (Flags) | | | |

CHECKLISTS

DELIVERY CHECKLIST

Inspect the broom thoroughly after assembly to be certain it is set up properly. The following checklist is a reminder of points to inspect. Check off each item as it is found satisfactory or after proper adjustment is made.

- Check operator's manual and familiarize the operator with all sections of it.
- Check that all safety shielding is in place.
- Check all bolts to be sure they are tight or adjusted properly at hinged locations.
- Check that all cotter pins are properly installed.
- Check PTO driveline. Make sure it is the correct length to operate broom with intended tractor.
- Check that all lubrication points with grease fittings have been lubricated.
- Check broom attitude, after mounting on tractor.
- Check that gearbox is properly serviced and seals are not leaking.
- All safety signs (decals) in place and readable.
- When the broom is transported on a road or highway at night or during the day, safety devices should be used for adequate warning to operators of other vehicles.

DAILY CHECKLIST

- Check that 3 pt. mounted broom is properly and securely attached to tractor.
- During inspection, check that all nuts and bolts are secure and that all safety shields are in place.
- Check condition of brush core assembly and security of attachment.
- Do not put broom into service unless brush wafers are intact and in good condition.
- Do not put broom into service unless all shields and guards are in place and in good condition. Replace if damaged.
- Make sure spring-activated locking pin or collar slides freely and is seated firmly in tractor PTO spline groove and gearbox shaft.
- Always wear relatively tight and belted clothing to avoid entanglement in moving parts. Wear sturdy, rough-soled work shoes and protective equipment for eyes, hair, hands, hearing, and head.

To the Owner/Operator/Dealer

All implements with moving parts are potentially hazardous. There is no substitute for a cautious, safe-minded operator who recognizes the potential hazards and follows reasonable safety practices. The manufacturer has designed this implement to be used with all its safety equipment properly attached to minimize the chance of accidents.

BEFORE YOU START!!

Read the safety messages on the implement and shown in your manual.
Observe the rules of safety and common sense!



THIS SYMBOL MEANS

- ATTENTION!
- BECOME ALERT!
- YOUR SAFETY IS INVOLVED!

THIS SAFETY ALERT SYMBOL IDENTIFIES IMPORTANT SAFETY WARNING MESSAGES. CAREFULLY READ EACH WARNING MESSAGE THAT FOLLOWS. FAILURE TO UNDERSTAND AND OBEY A SAFETY WARNING, OR RECOGNIZE A SAFETY HAZARD, COULD RESULT IN AN INJURY OR DEATH TO YOU OR OTHERS AROUND YOU. THE OPERATOR IS ULTIMATELY RESPONSIBLE FOR THE SAFETY OF HIMSELF, AS WELL AS OTHERS, IN THE OPERATING AREA OF THE TRACTOR AND ATTACHED EQUIPMENT.

UNDERSTAND SIGNAL WORDS

Note the use of the signal words **DANGER**, **WARNING** and **CAUTION** with the safety messages. The appropriate signal word for each has been selected using the following guidelines:

DANGER: Indicates an imminently hazardous situation that, if not avoided, will result in death or serious injury. This signal word is to be limited to the most extreme situations typically for machine components which, for functional purposes, cannot be guarded.

WARNING: Indicates a potentially hazardous situation that, if not avoided, could result in death or serious injury, and includes hazards that are exposed when guards are removed. It may also be used to alert against unsafe practices.

CAUTION: Indicates a potentially hazardous situation that, if not avoided, may result in minor or moderate injury. It may also be used to alert against unsafe practices.

If you have questions not answered in this manual or require additional copies or the manual is damaged, please contact your dealer or the manufacturer directly.

IMPORTANT SAFETY INFORMATION!

Working with unfamiliar equipment can lead to careless injuries. Read this manual, and the manual for your tractor, before assembly or operating, to acquaint yourself with the machines. It is the Implement owner's responsibility, if this machine is used by any person other than yourself, is loaned or rented, to make certain that the operator, prior to operating:

1. Reads and understands the operator's manuals.
2. Is Instructed in safe and proper use.



The use of this equipment is subject to certain hazards which cannot be protected against by mechanical means or product design. All operators of this equipment must read and understand this entire manual, paying particular attention to safety and operating instructions, prior to using. If there is something in this manual you do not understand, ask your supervisor, or your dealer, to explain it to you.

SAFETY INSTRUCTIONS (continued)



EQUIPMENT SAFETY GUIDELINES



Safety of the operator is one of the main concerns in designing and developing a new piece of equipment. Designers and manufacturers build in as many safety features as possible. However, every year many accidents occur which could have been avoided by a few seconds of thought and a more careful approach to handling equipment. You, the operator, can avoid many accidents by observing the following precautions in this section. To avoid personal injury, study the following precautions and insist those working with you, or for you, follow them.

In order to provide a better view, certain photographs or illustrations in this manual may show an assembly with a safety shield removed. However, equipment should never be operated in this condition. Keep all shields in place. If shield removal becomes necessary for repairs, replace the shield prior to use.



Replace any CAUTION, WARNING, DANGER or instruction safety sign that is not readable or is missing. Location of such safety signs is indicated in this booklet.



Never use alcoholic beverages or drugs which can hinder alertness or coordination while operating this equipment. Consult your doctor about operating this machine while taking prescription medications.



Review the safety instructions with all users annually.



This equipment is dangerous to children and persons unfamiliar with its operation. The operator should be a responsible adult familiar with farm machinery and trained in this equipment's operations. **Do not allow persons to operate or assemble this unit until they have read this manual and have developed a thorough understanding of the safety precautions and of how it works.**



To prevent injury or death, use a tractor or skid steer equipped with a Roll-Over Protective System (ROPS). Do not paint over, remove or deface any safety signs or warning signs on your equipment. Observe all safety signs and practice the instruction on them.



Never exceed the limits of a piece of machinery. If its ability to do a job, or to do so safely, is in question – **DON'T TRY IT.**



Do not modify the equipment in any way. Unauthorized modification may impair the function and/or safety and could affect the life of the equipment.





In addition to the design and configuration of this implement, including Safety Signs and Safety Equipment, hazard control and accident prevention are dependent upon the awareness, concern, prudence, and proper training of personnel involved in the operation, transport, maintenance, and storage of the machine. Refer also to Safety Messages and Operation Instructions in each of the appropriate sections of the Power Unit and 3 Pt. Broom Manuals. Pay close attention to the Safety Signs affixed to the Power Unit and the 3 Pt. Broom.

SAFETY INSTRUCTIONS (continued)





PREPARATION

-  Never operate the power unit and 3 pt. broom until you have read and completely understand this manual, the Power Unit Operator's Manual, and each of the Safety Messages found on the safety signs on the tractor or skid steer and broom.

-  Personal protection equipment including hard hat, safety glasses, sturdy rough-soled safety shoes, and gloves are recommended during assembly, installation, operation, adjustment, maintaining, repairing, removal, or moving the implement. Do not allow long hair, loose fitting clothing or jewelry to be around moving parts. Always wear relatively tight and belted clothing to avoid entanglement in moving parts.

-  **PROLONGED EXPOSURE TO LOUD NOISE MAY CAUSE PERMANENT HEARING LOSS!**
Power units with or without implements attached can often be noisy enough to cause permanent, partial hearing loss. We recommend that you wear hearing protection on a full-time basis if the noise in the Operator's position exceeds 80db. Noise over 85db on a long-term basis can cause severe hearing loss. Noise over 90db adjacent to the Operator over a long-term basis may cause permanent, total hearing loss. **NOTE:** Hearing loss from loud noise (from tractors, chain saws, radios, and other such sources close to the ear) is cumulative over a lifetime without hope of natural recovery.

-  Operate the broom only with a power unit equipped with an approved Roll-Over Protective System (ROPS). Always wear your seat belt on tractors equipped with a ROPS. Serious injury or even death could result from falling off the tractor – particularly during a turnover when the operator could be pinned under the ROPS or the tractor. Keep foldable ROPS systems in "locked up" position at all times.

-  PTO powered broom's operating power is supplied from tractor PTO. Refer to your tractor manual for PTO engagement and disengagement instructions. Always operate PTO in 540 RPM range. Know how to stop tractor and broom quickly in case of an emergency. When engaging PTO, the engine RPM should always be low.

-  Check the tractor master shield over the PTO stub shaft. Make sure it is in good condition and fastened securely to the tractor. Purchase a new shield if old shield is damaged or missing.

-  Operate only in daylight or good artificial light.

-  Ensure 3 pt. broom is properly mounted, adjusted and in good operating condition.

-  Make sure driveline spring-activated locking pin or balls operate freely and are seated firmly in tractor PTO stub shaft groove and gearbox shaft.

-  Ensure that all safety shielding and safety signs are properly installed and in good condition.

SAFETY INSTRUCTIONS (continued)





OPERATIONAL SAFETY

-  The use of this equipment is subject to certain hazards which cannot be protected against by mechanical means or product design. All operators of this equipment must read and understand this entire manual, paying particular attention to safety and operating instructions, prior to using. If there is something in this manual you do not understand, ask your supervisor, or your dealer, to explain it to you.

-  Most accidents occur because of neglect or carelessness. Keep all helpers and bystanders fifty feet (50') from an operating power unit and attached equipment. Only properly trained people should operate this machine. It is recommended the tractor be equipped with a Rollover Protection System (ROPS) and a seat belt that is used. Always stop the power unit, set brake, shut off the engine, remove the ignition key, and lower attachment to the ground before dismounting. Never leave equipment unattended with the engine running.

-  Please remember it is important that you read and heed the safety signs on the attachment and power unit, and the safety rules set forth. Clean or replace all safety signs if they cannot be clearly read and understood. They are there for your safety as well as the safety of others. The safe use of this machine is strictly up to you, the operator.

-  Be sure power unit is in good condition. Read all the safety precautions and make sure all operators are familiar with the safety rules of operation. Working with unfamiliar equipment can lead to careless injuries. It is the equipment owner's responsibility, if this machine is used by any person other than yourself, is loaned or rented, to make certain that the operator, prior to operating:
 1. Reads and understands the operator's manuals.
 2. Is instructed in safe and proper use.

-  Train all new personnel and review instructions frequently with existing workers. A person who has not read and understood all operating and safety instructions is not qualified to operate the machine. An untrained operator exposes himself and bystanders to possible serious injury or death.

-  Do not allow children to operate this machine.

-  Know your controls and how to stop the power unit and engine quickly in an emergency. **READ THIS MANUAL AND THE ONE PROVIDED WITH YOUR POWER UNIT.**

-  When the use of hand tools is required to perform any part of assembly, installation, adjustment, maintaining, repairing, removal, or moving the implement, be sure the tools used are designed and recommended by the tool manufacturer for that specific task.













-  Personal protection equipment including safety glasses, safety shoes, and gloves are recommended during assembly, installation, operation, adjustment, maintaining, repairing, removal, or moving the attachment.

-  Always use two people to handle heavy, unwieldy components during assembly, installation, removal, or moving the attachment.

SAFETY INSTRUCTIONS (continued)















OPERATIONAL SAFETY (continued)

-  Always stop the power unit, set brake, shut off the engine, remove the ignition key, lower implement to the ground and allow rotating brush to come to a complete stop before dismounting. Never leave equipment unattended with the power unit running.
-  Never place hands or feet under broom with power unit engine running or before you are sure all motion has stopped. Stay clear of all moving parts. Keep hands, feet, hair, and clothing away from moving parts.
-  Do not reach or place yourself under equipment until it is blocked securely.
-  Take all possible precautions when leaving unit unattended: Disengage PTO, set parking brake, stop engine and remove key from ignition. Park in level area.
-  Do not allow riders on the broom or power unit at any time. There is no safe place for any riders.
-  Disengage power takeoff (PTO) or hydraulic power and place transmission into neutral before attempting to start engine.
-  Do not operate unless all personnel, livestock, and pets are fifty feet away to prevent injury by thrown objects. Never direct discharge toward anyone.
-  Install and secure all guards and shields before starting or operating.
-  PTO powered brooms are designed for use only on tractors with 540 RPM power takeoff.
-  Many varied objects, such as wire, cable, rope, or chains, can become entangled in the rotating brush core. These items could then swing outside the housing at great velocities. Such a situation is extremely hazardous. Inspect the area for such objects before sweeping. Removing any like object from the site. Never allow the rotating brush to contact such items.
-  Use extreme care and maintain minimum ground speed when transporting on hillside, over rough ground and when operating close to ditches or fences. Be careful when turning sharp corners.
-  Reduce speed on slopes and sharp turns to minimize tipping or loss of control. Be careful when changing directions on slopes. Do not start or stop suddenly on slopes. Avoid operation on steep slopes.
-  When using a tractor mounted unit, a minimum 20% of tractor and equipment weight must be on tractor front wheels. Without this weight, tractor could tip over, causing personal injury or death. The weight may be attained with a front end loader, front wheel weights, ballast in tires or front tractor weights. When attaining a minimum 20% of tractor and equipment weight on the front wheels, you must not exceed the ROPS weight certification. Weigh the tractor and equipment. Do not guess or estimate!

SAFETY INSTRUCTIONS (continued)















OPERATIONAL SAFETY (continued)

-  Before leaving the operator's area for any reason – lower the sweeper to the ground, stop the power unit engine, set the brakes and remove the key from the ignition.
-  Minimize flying debris – use the slowest brush speed that will do the job.
-  When sweeping on rough terrain, reduce speed to avoid "bouncing" the sweeper. Loss of steering can result.
-  Leave the brush hood (shield) and all other shields and safety equipment in place when operating the sweeper and prime mover.
-  When sweeping, adhere to all government rules, local laws and other professional guidelines for your sweeping application.
-  The guards, flaps, driveline shields, and gearbox shields should be used and maintained in good working condition. They should be inspected carefully, at least daily, for missing or broken shields, or guards. Missing broken, or worn items must be replaced at once to reduce the possibility of injury from thrown objects or entanglement.
-  Never raise the sweeper more than a few feet off the ground. The sweeper can tip back or the prime mover can tip over causing death or serious injury.
-  When maneuvering close to buildings or passing through narrow areas, be sure to allow sufficient clearance for the power unit and broom attachment. Drive slowly.
-  Operate broom from operator's seat only. Remain at controls until operating cycle is complete.
-  Only use a power unit equipped with a ROPS cab or rollover protective structure. Keep foldable ROPS systems in "locked up" position at all times. Keep seat belt fastened.
-  Do NOT exceed 12 miles per hour when operating.
-  Keep hands and feet away from broom pivot points and from under brush core.
-  Keep alert and watch the rear as well as the front when working with the broom.

SAFETY INSTRUCTIONS (continued)

















TRANSPORT SAFETY

-  Comply with state and local laws governing highway safety and movement of machinery on public roads.
-  The use of flashing amber lights is acceptable in most localities. However, some localities prohibit their use. Local laws should be checked for all highway lighting and marking requirements.
-  When driving the tractor and equipment on the road or highway under 20 mph (32 kph) at night or during the day, use flashing amber warning lights and a slow moving vehicle (SMV) identification emblem.
-  Always be sure the implement is in the proper raised position for transport.
-  Reduce speed when transporting mounted implements to avoid bouncing and momentary loss of steering control.
-  Plan your route to avoid heavy traffic.
-  Do not drink and drive!
-  Watch for traffic when operating near or crossing roadways.
-  Turn curves or go up or down hills only at a low speed and at a gradual steering angle. Make certain that at least 20% of the tractor's weight is on the front wheels to maintain safe steering. Slow down on rough or uneven surfaces, and loose gravel.
-  Use extreme care and maintain minimum ground speed when transporting on hillside, over rough ground and when operating close to ditches or fences. Be careful when turning sharp corners.
-  Never allow riders on either power unit or broom. Falling off can kill.
-  Be a safe and courteous driver. Always yield to oncoming traffic in all situations, including narrow bridges, intersections, etc.
-  Do not exceed 20 mph (32 kph). Reduce speed on rough roads and surfaces.

SAFETY INSTRUCTIONS (continued)









MAINTENANCE SAFETY

-  Before adjusting or servicing the broom – lower the broom to the ground, stop the prime mover engine, set the brakes and remove the key from the ignition.
-  Repair or adjust the broom in a safe area, away from road traffic and other hazards.
-  Make sure there is plenty of ventilation. Never operate the engine of the vehicle in a closed building. The exhaust fumes may cause asphyxiation.
-  Before working on this machine, drive to a level area, disengage the PTO, lower implement (or if working underneath, raise and block securely), shut off the engine, set the brakes, and remove the ignition keys.
-  Be certain all moving parts on attachments have come to a complete stop before attempting to perform maintenance.
-  Never work under equipment unless it is blocked securely. Never depend on hydraulic system to keep implement in raised position.
-  Keep all persons away from operator control area while performing adjustments, service, or maintenance.
-  Always use personal protection devices such as eye, hand and hearing protectors, when performing any service or maintenance.
-  When working on or around the broom, lower it to the ground or secure it with transport chains.
-  Periodically tighten all bolts, nuts and screws and check that all cotter pins are properly installed to ensure unit is in a safe condition.
-  When completing a maintenance or service function, make sure all safety shields and devices are installed before placing unit in service.
-  Remove hydraulic pressure prior to doing any maintenance. Place the broom on the ground or securely blocked up, disengage the PTO, and turn off the engine. Push and pull the remote cylinder lever in and out several times to relieve hydraulic pressure.
-  Never use your hands to locate a hydraulic leak on attachments. Use a small piece of cardboard or wood. Hydraulic fluid escaping under pressure can penetrate the skin.
-  Openings in the skin and minor cuts are susceptible to infection from hydraulic fluid. If injured by escaping hydraulic fluid, see a doctor at once. Gangrene and death can result. Without immediate medical treatment, serious infection and reactions can occur.

SAFETY INSTRUCTIONS (continued)







MAINTENANCE SAFETY (continued)

-  After servicing, be sure all tools, parts and service equipment are removed.
-  Keep polypropylene brush material away from intense heat or flame.
-  Check to ensure all safety signs are installed and in good condition. (See safety sign section for location drawing.)
-  A fire extinguisher and first aid kit should be kept readily accessible while performing maintenance on this equipment.
-  Never replace hex bolts with less than grade five bolts unless otherwise specified, i.e. shear bolts. Refer to bolt torque chart for head identification marking.
-  Where replacement parts are necessary for periodic maintenance and servicing, genuine factory replacement parts must be used to restore your equipment to original specifications. The manufacturer will not claim responsibility for use of unapproved parts and/or accessories and other damages as a result of their use.
-  If equipment has been altered in any way from original design, personal injury could result. The manufacturer does not accept any liability for injury or warranty.



STORAGE SAFETY

-  Following operation, or when unhooking, stop the tractor, set the brakes, disengage the PTO, shut off the engine and remove the ignition keys.
-  Store the unit in an area away from human activity. Do not permit children to play on or around the stored unit.
-  Do not park equipment where it will be exposed to livestock for long periods of time. Damage and livestock injury could result.
-  Make sure all parked machines are on a hard, level surface and engage all safety devices. Storage location should be level and solid to make connecting and unconnecting to power unit easy.
-  If blocking is used, make sure it is solid and secure before leaving area.

SAFETY SIGNS

⚠ WARNING

TO AVOID SERIOUS INJURY OR DEATH:

- Read Operator's Manual before operating, servicing or repairing equipment. Follow all safety rules and instructions. (Manuals are available from your selling dealer.)
- Never allow riders.
- Keep bystanders away from equipment during operation.
- Operate from operator's seat only.
- Keep all shields in place and in good condition.
- Lower equipment to ground, stop engine, remove key and set brake before dismounting power unit.
- Never allow children or untrained persons to operate equipment.

FAILURE TO FOLLOW THESE INSTRUCTIONS CAN RESULT IN INJURY OR DEATH.

101289

⚠ CAUTION

- Do not operate sweeper without reading the owner's manual and operating instructions completely and being familiar with the operation of the sweeper. If operating instructions are missing, contact Worksaver, Inc.
- Keep bystanders away from equipment before operating.
- Never operate broom toward people, buildings, cars, etc.
- Lower equipment, stop engine and brush, allow all moving parts to stop, remove key and set brake before adjusting or servicing broom.
- Eye protection must be worn at all times by operator and anyone near the discharge area of the brush.
- Do not operate broom or power unit unless all shields are in place.
- Keep polypropylene material away from intense heat and flames.
- Do not operate this product on any roof area, unless roof area complies with Federal OSHA Law Section 1826.500 on perimeter guarding.

101391

⚠ WARNING



CRUSHING AND PINCHING HAZARD

- Be extremely careful with various parts of the machine. Pivoting blade can crush or pinch body parts.
- Operate controls from operator's seat only.
- Make sure parking brake is engaged before leaving operator's seat.
- Stand clear of machine while in operation or when it is being raised or lowered.

FAILURE TO FOLLOW THESE INSTRUCTIONS COULD RESULT IN SERIOUS INJURY OR DEATH.

101288

⚠ WARNING

Stand clear

101027

Notice

When 3 Pt. Hitch is fully raised, be sure tractor to gearbox driveline shaft does not "bottom out" when collapsed. Damage to tractor, shaft or sweeper gearbox may result.

Check manual for proper method to shorten driveshaft assembly. **DO NOT** make it too short.

101390

BE CAREFUL!

Use a clean, damp cloth to clean safety decals. Avoid spraying to close to decals when using a pressure washer; high-pressure water can enter through very small scratches or under edges of decals causing them to peel or come off.

REMEMBER: If Safety Signs have been damaged, removed, become illegible or parts replaced without Signs, new Safety Signs must be applied. New Safety Signs are available from your authorized distributor or factory.

SAFETY SIGN LOCATION

The types of safety signs and locations on the equipment are shown in the illustration below. Good safety requires that you familiarize yourself with various safety signs, the type of warning and the area, or particular function related to that area, that requires your SAFETY AWARENESS.

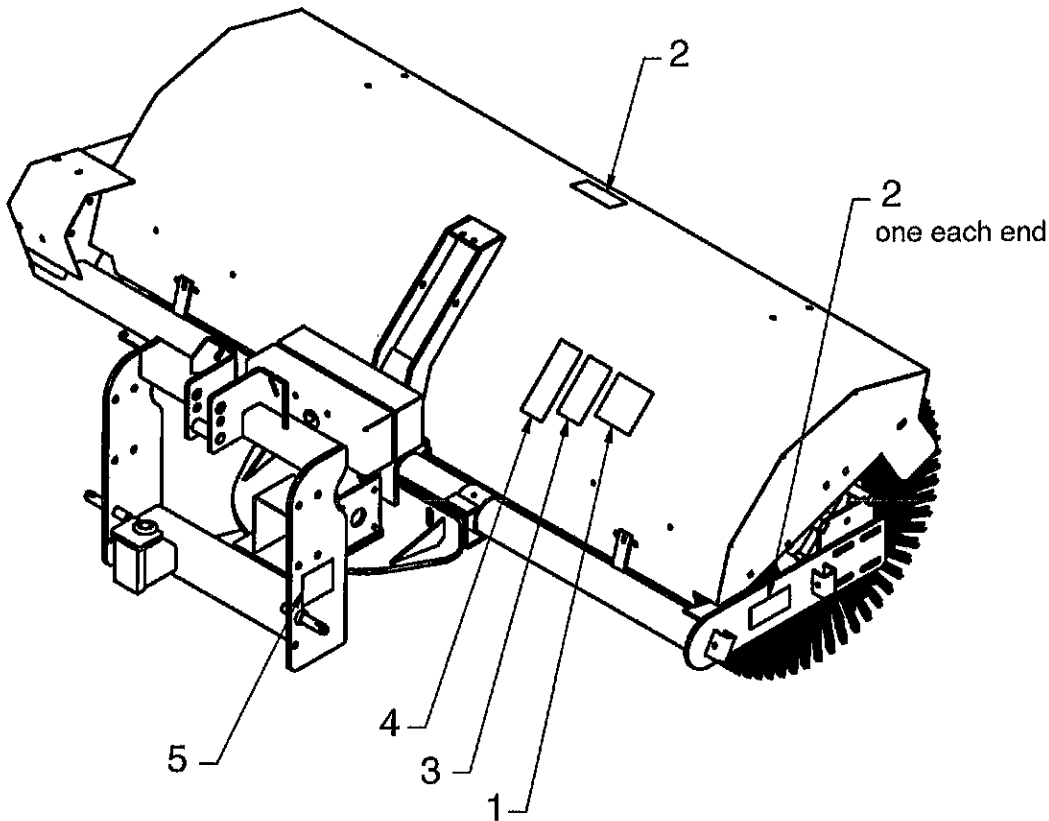

| Ref. No. | Part No. | Description | No. Req'd. |
|----------|----------|-----------------------------------------------|------------|
| 1 | 101289 | Safety Sign - Warning (Avoid Serious Injury) | 1 |
| 2 | 101027 | Safety Sign - Warning (Stand Clear) | 3 |
| 3 | 101288 | Safety Sign - Warning (Crushing and Pinching) | 1 |
| 4 | 101391 | Safety Sign - Caution | 1 |
| 5 | 101390 | Notice - 3 pt. | 1 |

The model and serial number plate is located on the right side of the vertical part of the main frame.

The serial number is also stamped into the top cross tube of the mounting frame.

INSTRUCTIONS

TRACTOR REQUIREMENTS AND PREPARATION

The 3 pt. mounted PTO driven brooms are designed for use in road and parking lot maintenance, construction cleanup, snow removal, grounds maintenance and similar operations.

The Model RMB 3 pt. Brooms are designed to attach to Category I or Category II hitches. For attachment to a Category II 3 pt. Hitch, you must order Category II hitch pins or use Category I to II adapter bushings.

Depending on the size of broom being used, the tractor should have at least 30 horsepower or up to 65 horsepower and be equipped with a 540 rpm (power takeoff) in good working condition.

The tractor should have a 3 pt. lifting capacity of 1,000 lbs. or more.

It is recommended that only tractors with wide front axles be used with the broom. Tricycle front wheel arrangements are inherently unstable and tractor roll-over accidents are more likely to occur.

The tractor also needs lift arm stabilizer bars or sway blocks to control side movement of the broom.

Check the tractor's 3 pt. hydraulic lift system. Refer to your tractor operator's manual or dealer for any adjustments necessary to put the hydraulic system in good working order. (I&T shop manuals will list most specifications and adjustment instructions – available from most farm equipment dealers.)

Be sure tires and rims are in good condition. Inflate tires to the proper recommended air pressure.

Check the tractor master shield over the PTO stub shaft. Make sure it is in good condition and fastened securely to the tractor. Purchase a new shield if old shield is damaged or missing. (You may have to use a tractor salvage yard for replacement parts on older tractors.)

A ROPS (Roll-Over Protection Structure) and a seat belt must be installed on all tractors. Contact your local dealer for a ROPS for your tractor.

CAUTION!

Be sure your tractor is in good condition. Read all the safety precautions and make sure all tractor operators are familiar with the safety rules of operation.

The operator is responsible for the safe operation of this broom. The operator must be properly trained. Operators should be familiar with the broom and tractor and all safety practices before starting operation. Read the safety rules and safety signs on pages 5-14.

WARNING!

A heavy load can cause instability in driving a tractor. Make sure the front of the tractor is properly counterbalanced with weights. Always drive slowly - especially around turns. An unstable tractor could steer badly and possibly tip over, causing injury or death.

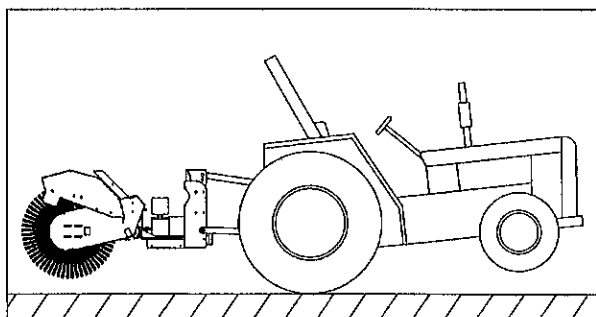

Tractor Stability

WARNING!

When using 3 pt. hitch equipment, a minimum 20% of tractor and equipment weight must be on tractor front wheels. Without this weight, tractor could tip up, causing possible loss of control and possible personal injury or death. The weight may be attained with a front end loader, front wheel weights, ballast in tires or front tractor weights. When attaining a minimum 20% of tractor and equipment weight on the front wheels, you must not exceed the ROPS weight certification. Weigh the tractor and equipment. DO NOT GUESS OR ESTIMATE!

This broom has been assembled to sweep while the tractor is traveling forward. You may sweep while moving in reverse. See maintenance section on reversing the broom rotation to sweep while driving in reverse.



**SAFETY . . .
YOU CAN LIVE WITH IT!**

INSTRUCTIONS (continued)

ASSEMBLY / INSTALLATION

This unit is shipped partially assembled. Carefully follow instructions for final assembly.

Refer to the "exploded view" of the 3 pt. mounted rotary broom on page 37 of this manual. Become familiar with the relationship of the various components and parts shown.

Before attempting assembly check the following items. Having all the needed parts and equipment readily at hand will speed up your assembly task and will make the job as safe as possible.

- Find a location that is solid and level to assemble and install the 3 pt. broom on your power unit.
- Check for fasteners and pins that were shipped with the broom. If a part or fastener is temporarily removed for assembly reasons, remember where it goes. Keep the parts separated.
- Have a minimum of 2 people at hand during assembly.
- Have a fork lift or loader along with chains and safety stands that are sized for the job ready for the assembly task.

CONNECTING 3 PT. BROOM TO TRACTOR

1. Attach the Category I hitch pins to the 3 pt. mounting frame.
2. Attach a 39 link chain to each side of the 3 pt. mounting frame below each hitch pin. The chains need to be on the inside of the side plates and fastened with a 1/2" x 1 1/2" Gr. 5 bolt, flat-washer, lockwasher, and nut (figure 2).
3. Locate and pin each of the two keyhole plates to each side of the tractor lugs with pins from the tractor (figure 1).
4. Position the 3 pt. mounting frame behind the tractor with the half-moon swing plate toward the rear.
5. Lower the tractor 3 pt. lift arms.
6. Attach the tractor lift arms to the Cat. I hitch pins on the mounting frame. Note: If the tractor lift arms are for Cat. II hitches, then install Cat. II hitch pins or use Cat. II adapter bushings.
7. Connect the tractor toplinek to the top of the 3 pt. mounting frame. Secure with correct size toplinek pin (figure 3).

NOTE: For a Cat. I toplinek, use the middle 3/4" diameter hole and a Cat. I (3/4" dia.) pin. For a Cat. II toplinek, use the top large hole and a Cat. II (1" dia.) pin. Secure toplinek pins with a 7/16" 1/2 inch pin.

Continued on the next page

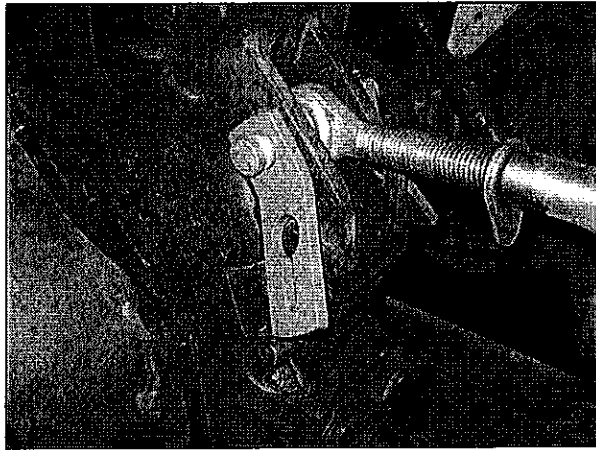

Figure 1

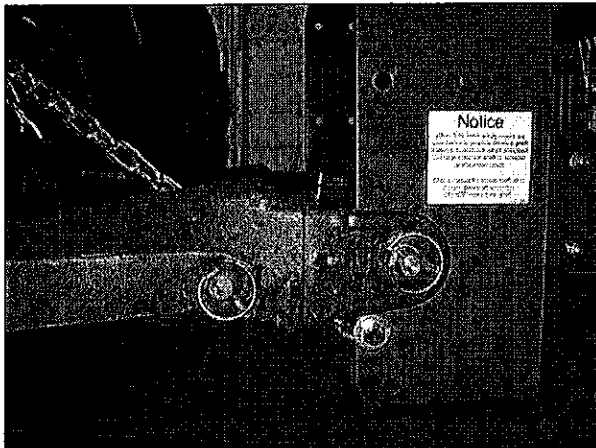

Figure 2

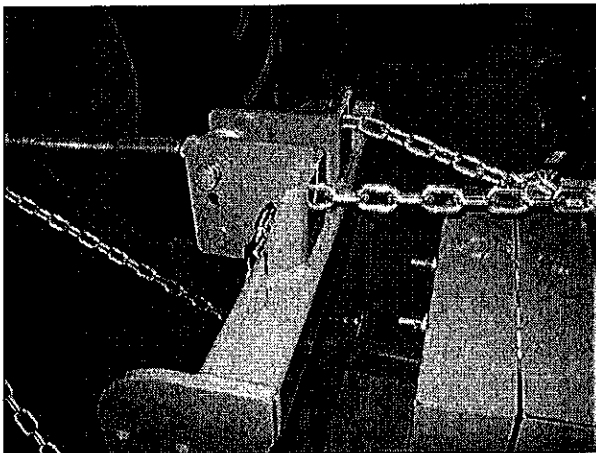

Figure 3

INSTRUCTIONS (continued)

ASSEMBLY / INSTALLATION (cont'd)

8. Adjusting support chains, which are attached to the 3 pt. mounting frame and keyhole plates.
 - a. Raise the 3 pt. hitch until the center of the mounting frame's rear half-moon plate is 14" (356 mm) above the ground. (Figure 4)
 - b. Select the link in each chain that will keep the frame at that measurement. (Length of chain from link should be same on both sides.)
 - c. Raise 3 pt. hitch slightly.
 - d. Place links (selected in 8b) in keyhole slots.
 - e. Lower 3 pt. hitch until chains are tight. Check that the center of plate is 14" (356 mm) above ground.

NOTE: For wet, heavy and/or deep snow, adjust support chains so mounting assembly is about 20" (508 mm) above the ground when unit is lowered.

NOTE: Avoid equipment damage. Positioning the broom too close to the ground (less than 14") can result in damage to broom hood or gearbox. Keep the correct distance.

9. Position the brush head assembly behind the mounting assembly (figure 5).
10. Align the slots in the rear half-moon plate and the brush head's pivot angle. Secure with the three (3) 5/8" carriage bolts, flatwashers, lockwashers, and nuts. Install all hardware before tightening (figure 6).

An open end 15/16" wrench is required.

NOTE: The top edge of the half-moon plate and the brush head pivot should be parallel with each other. This is important when adjusting the broom after installation.

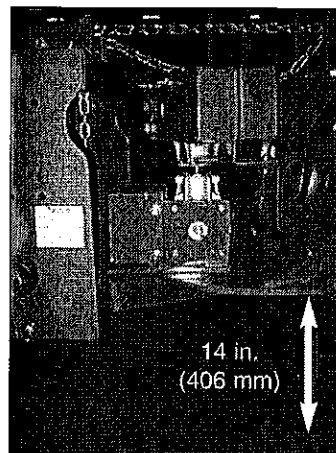

Figure 4

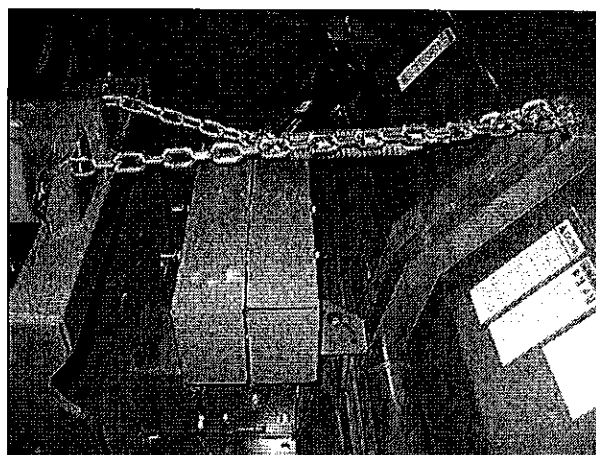

Figure 5

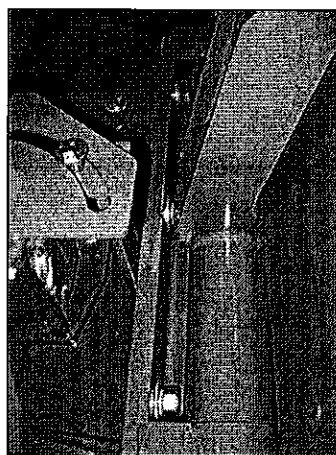

Figure 6

Continued on the next page

INSTRUCTIONS (continued)

ASSEMBLY / INSTALLATION (cont'd)

11. Install the spring-chain assembly (figure 7 shows spring-chain installed).
 - a. Place the tension spring on one end of the 27 link chain.
 - b. Attach the spring to the brush frame center upright.
 - c. Connect the chain into the RH chain holder slot on top of the 3 pt. mounting assembly.
12. Connect the transport chain, already bolted to the brush frame upright. To the LH chain holder slot (figure 8).
13. Install the driveline that connects the top gearbox to the RH side of the brush head.
 - a. Remove the shield over the jackshaft.
 - b. Install the 1/4" woodruff key in the slot of the jackshaft. Slide the 1.0" I.D. end of the driveline onto the 1.0" jackshaft and tighten the set screws.
 - c. Attach the other end of the driveline to the gearbox shaft. Make sure the end is locked in the groove of the 1 3/8" x 6 spline shaft.
 - d. Replace the shield over the jackshaft and tighten the bolts.
14. Install the PTO driveline to the lower gearbox shaft and the tractor PTO stub shaft. (Figure 9).

NOTE: It may be necessary to shorten the PTO driveline. The driveline must slip freely as the brush is raised and lowered. Carefully raise and lower the broom slowly to check that the telescoping PTO driveline is the proper length.

NOTE: Make sure the drivelines will not bottom out or separate when turning and/or going over rough terrain. (See page 22 for instructions on making a driveline shorter).

IMPORTANT NOTICE

Check the swinging drawbar of the tractor and make sure the PTO driveline assembly will not contact. The swinging drawbar can be moved forward on some tractors or it can be removed.

If the PTO driveline assembly contacts the swinging drawbar, damage will occur to the driveshaft shield and possibly the driveshaft itself. (NOT covered under warranty.)

Continued on the next page

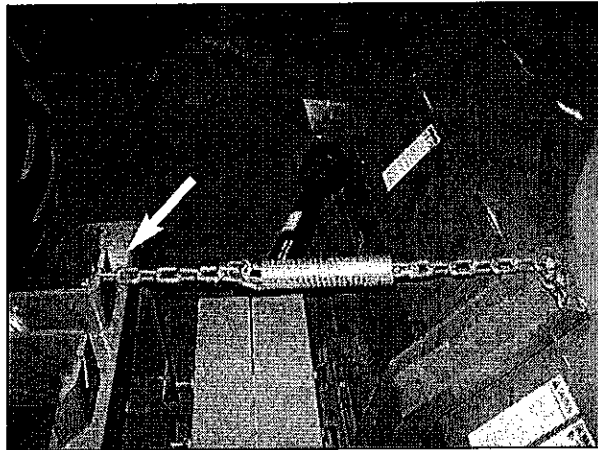

Figure 7

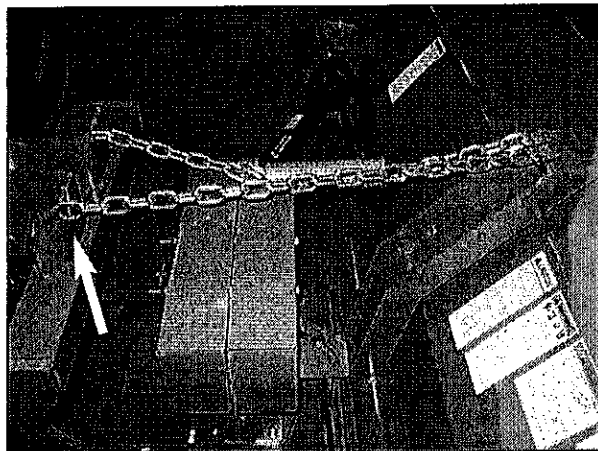

Figure 8

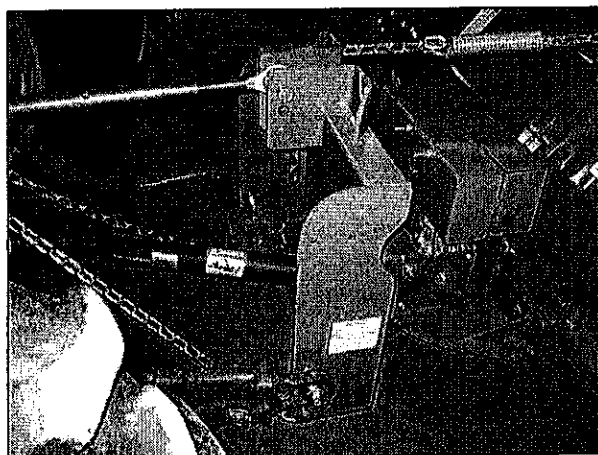

Figure 9

INSTRUCTIONS (continued)

ASSEMBLY / INSTALLATION (cont'd)

15. Adjust the topline so the broom mounting frame is perpendicular to the ground.

16. Install the manual or hydraulic angle option.

A. For the manual kit:

- a. Slide the two tubes together so the holes will align.
- b. Pin the tubes on the swivel ball mounts. The tube with five holes goes on the half-moon plate. (Figure 10).
- c. Secure the pins with cotter pins.
- d. Swing the broom to the desired angle. Check to align a set of holes in the tube.
- e. Insert the 5/16" lock pin into the aligned holes (figure 11).

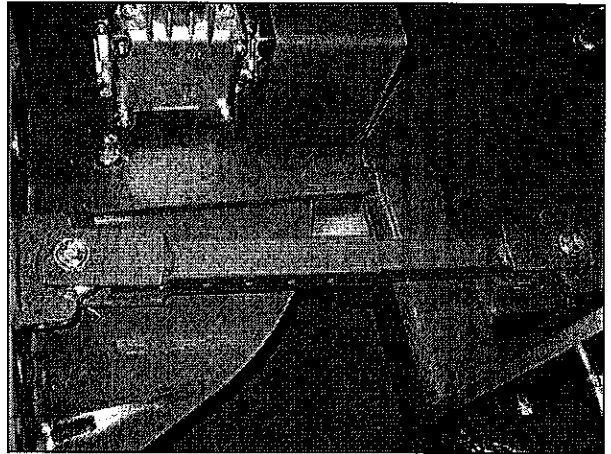

Figure 10

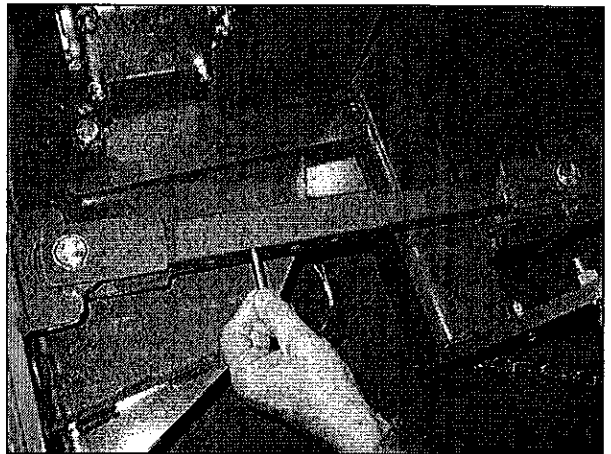

Figure 11

Continued on the next page

INSTRUCTIONS (continued)

ASSEMBLY / INSTALLATION (cont'd)

- B. For the hydraulic angle kit:
- Attach the elbow fittings on the hydraulic cylinder. The orifice fitting goes on the barrel-end port.
 - Install the hydraulic cylinder on the swivel ball mounts. The rod end of the cylinder goes on the half-moon plate.
Secure the pins with cotter pins.
 - Connect a hose to each fitting on the cylinder
 - Attach your quick-coupler fittings to the hose ends (quick-couplers to connect to the tractor remote hydraulic outlets are not supplied).
 - Connect the quick-couplers to the tractor hydraulic outlets.

NOTE: Additional hydraulic equipment, such as quick couplers and valves, that fit specific tractors is customer-supplied.

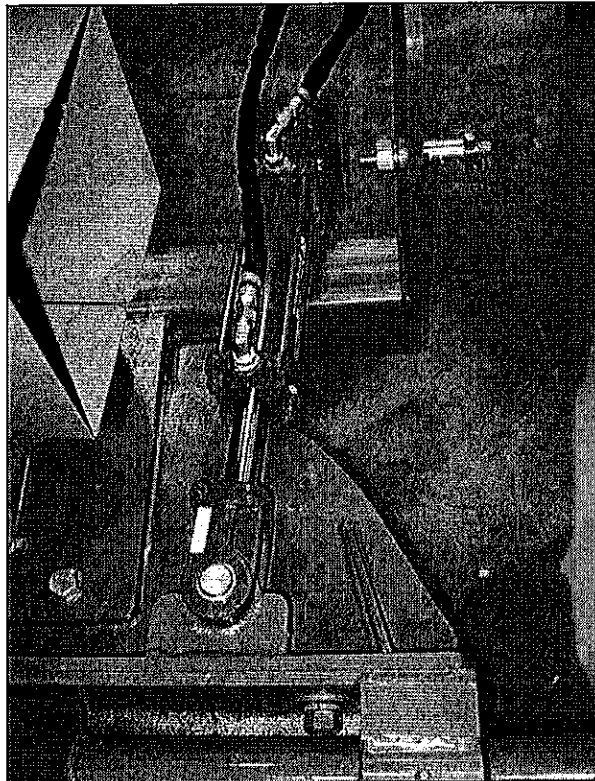

Figure 12

17. Install storage stands. Figure 13 shows stands fully installed.
- On one side of the brush head assembly, slide a straight stand into the tube near the bearing assembly. Align a hole in the stand with the one in the tube. Secure with a lock pin.
 - Slide an angled stand into the tube toward the front of the brush frame. Align holes and secure with a lock pin.
 - Repeat above two steps on the other side of the brush head assembly.

NOTE: Storage stands are designed to keep the brush off the ground when the broom is dismounted. When the broom is mounted, slide stands up in the tubes to keep them out of the way.

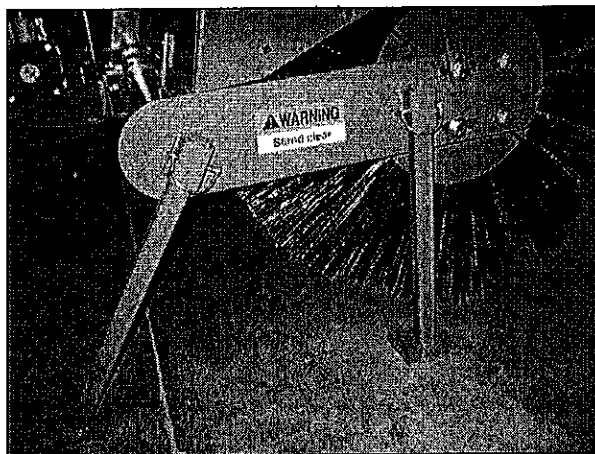

Figure 13

18. Install any other options. See the back of this manual for installation instructions.

19. Go to the Adjustments section.

INSTRUCTIONS (continued)

PTO DRIVELINE INSTALLATION

On new brooms, check PTO driveline for correct length for use with your tractor. (See below.)

Most swinging drawbars will have to be moved to a forward position or removed. Check the tractor swinging drawbar for interference with the PTO driveline before attempting to lift the broom with the 3 pt. hitch.

Tractor lift arm stabilizer bars or sway blocks must be used to control side movement of the broom.

In some cases it will be necessary to shorten the PTO assembly to match your particular tractor. The following procedure should be used:

1. Raise the tractor 3 pt. hitch so the input shaft of the gearbox is in line with the PTO shaft on the tractor. Shut down tractor, leaving broom 3 pt. mount in position of shortest distance between shafts. **SECURELY BLOCK IMPLEMENT IN POSITION.**

The minimum coupling length (overlap) must be no less than 180 mm (6 inches) in each work position.

Driveline travel must still be about 25 mm (1 inch) in the maximum coupling (overlap) position. (See Figure 14.)

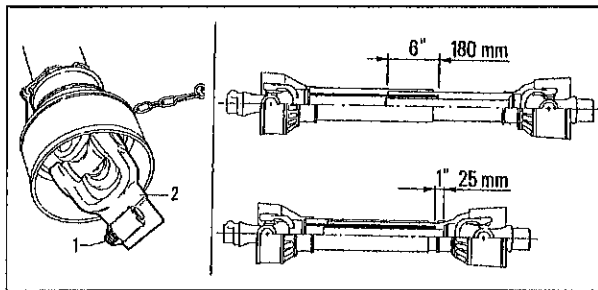

Figure 14

Couple the two end yokes of the driveline on the tractor PTO and gearbox shaft and check that they are perfectly locked in place.

To achieve this, slide the end yokes on to the 6 spline shafts on both the tractor and broom gearbox. Pull the slide ring back away from the end of the yoke to release the locking balls. Make sure that the locking balls go into the relative grooves in the 6 spline shafts and that the slide ring can go back to the ball lock position.

An unlocked shaft would slip out of position, causing notable mechanical damage and serious injury to anyone near.

If the driveline is too long, it should be shortened in the following way:

- Set the machine PTO input gearbox shaft at a minimum distance from the tractor PTO stub shaft; then brake the tractor and switch the engine off.

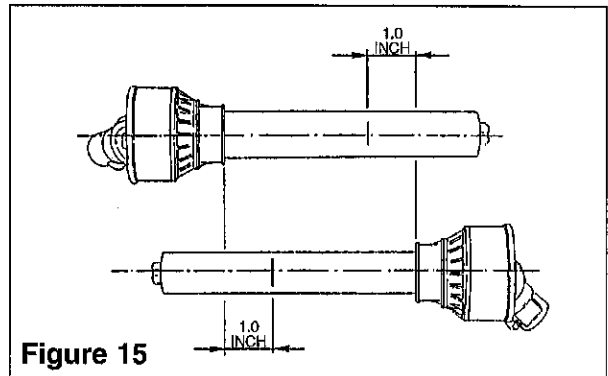

Figure 15

1. Place the two halves of the driveline together, keeping them parallel (see Figure 15). Using a felt-tip pen, matchmark the place where the two halves must be shortened, measuring 1.0 inch from the beginning of each half, as shown in Figure 15.

Double check before making any cuts. Cut PTO drivelines cannot be returned.

2. Raise and lower the broom to determine position with greatest distance between the PTO shaft and gearbox input shaft. Shut tractor off, leaving broom in position of greatest distance between shafts. **SECURELY BLOCK BROOM IN POSITION.**

3. Hold driveline sections parallel to each other and check for **minimum 6" (15cm) overlap**. If driveline has been marked for cutting, overlap will be the distance between the two marks. If driveline has less than minimum overlap, **do not use**. Contact authorized Worksaver dealer.

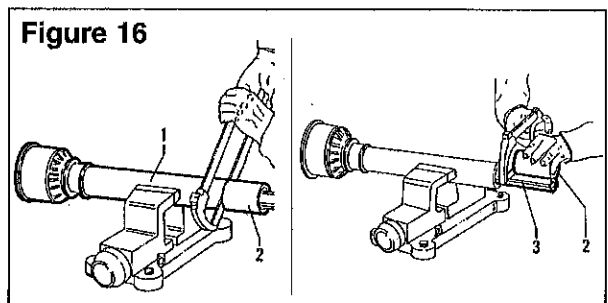

Figure 16

INSTRUCTIONS (continued)

PTO DRIVELINE INSTALLATION (cont'd)

4. If driveline must be cut to a shorter length, clamp driveline in a well padded vise to prevent damage to the shield. Cut off shield where marked. Using cut-off section of shield as a guide, cut shaft the same amount. (Figure 16.)
5. Repeat the procedure to the other driveline half. Remove all burrs and cuttings.
6. Apply multi-purpose grease to inside of outer (female) driveline section. Assemble driveline and install on tractor and broom. Pull on each driveline section to be sure yokes lock into place. Make certain driveline shielding is in place and in good condition.

WARNING!

When attaching PTO yoke to tractor PTO shaft, it is important that spring-activated locking pin or balls operate freely and are seated in groove on PTO shaft. A loose shaft could slip off and result in personal injury or damage to equipment.

7. Carefully raise and lower the broom and check to be sure the PTO assembly does not jam. If it does, cut equal amounts from each half of the PTO assembly.

Then raise the tractor lift very slowly, making sure that the front drive shaft shield does not hit the front of the broom. If it does, damage will be done to the drive shaft shield and, if interference is bad enough, it WILL also damage the drive shaft itself.

NOTE: This type of damage is **NOT** covered under warranty, as it is totally under the control and the responsibility of the operator.

Use the lift control limiting stop on the tractor control lever to limit the upward travel of the lever so the lift cannot be raised high enough to cause contact between the drive shaft shield and front shielding. It is recommended that the broom not be raised more than 12 inches off the ground with the PTO engaged.

8. Now lower the broom and check the swinging drawbar of the tractor and make sure the PTO driveline assembly will not contact. The swinging drawbar can be moved forward on some tractors or it can be removed.

NOTE: This type of damage is **NOT** covered under warranty, as it is totally under the control and the responsibility of the operator.

**ALWAYS OBEY ALL
SAFETY RULES!!
ALWAYS BE CAREFUL!!**

INSTRUCTIONS (continued)

ADJUSTING FOR WORK

LEVELING

For best performance, level the broom immediately after installation and as a part of regular maintenance.

1. Move the unit to a level dusty, paved surface.
2. Lower the brush head assembly so bristle tips are about 2 in. (51 mm) off the ground.
3. Swing the brush head assembly to a straight ahead position.
4. At each end of the brush head, measure from the center of the core shaft to the ground (Figure 17).
 - If measurements are the same, go to step 5.
 - If measurements are not equal, make sure the top edges of the mounting assembly and brush head plates are parallel. Adjust, if necessary, and tighten the hardware. Then, lengthen or shorten the adjustable hitch arm to make measurements the same. Repeat step 4 until measurements are equal.
5. Swing the broom to the right. Take measurements as in step 4. Swing the broom to the left. Measure again.
 - If all measurements are equal, the broom is level.
 - If measurements are not equal, level the mounting assembly with the topline. Follow instructions shown in Figure 18. Then, go back to the beginning of step 5; repeat until the broom is level.

NOTE: Make sure the telescoping PTO driveline does not hit the mounting frame when the unit is raised. Reset lift limits if necessary.

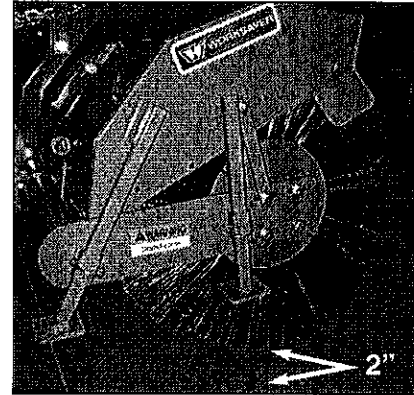

Figure 17

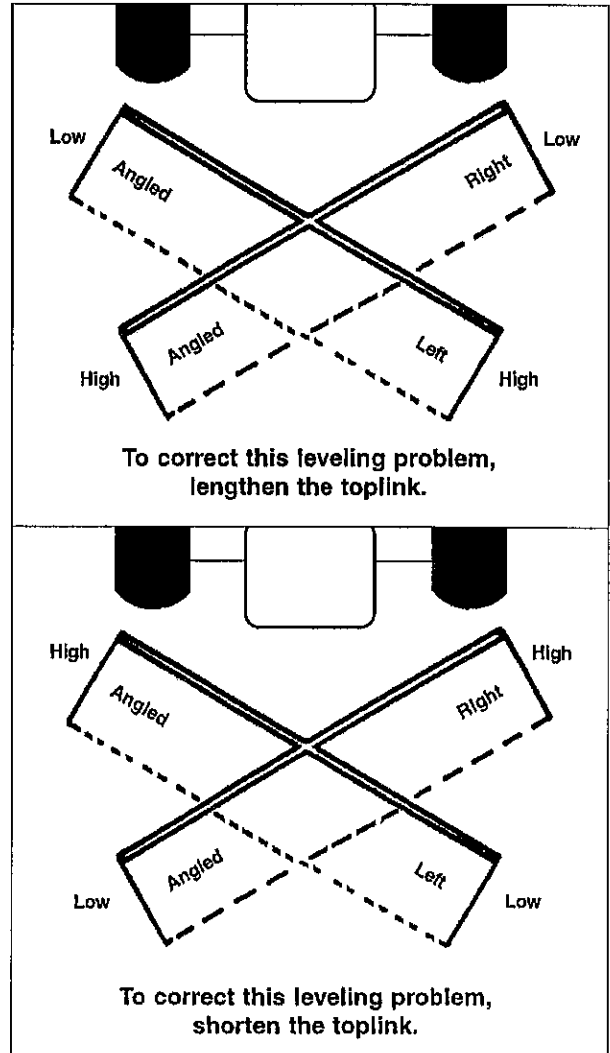

Figure 18

Continued on the next page

INSTRUCTIONS (continued)

ADJUSTING FOR WORK (cont'd)

ADJUSTING BRUSH PATTERN

A properly adjusted brush offers the best sweeper performance. To check the brush pattern:

1. Move the broom to a dusty, flat surface.
2. Set the prime mover's parking brake and leave the engine running.
3. Start the broom at a slow speed; then, lower it completely to the surface so bristle tips touch the ground. Run the broom in a stationary position for 30 seconds.
4. Raise the broom and back away; switch off the engine and remove the key. The brush pattern left in the dust should be 2-3 in. wide, running the entire length of the brush. (Compare the swept area with Figure 19.)
5. Adjust the brush pattern as necessary according to instructions found in Adjusting Spring-Chain Assembly.

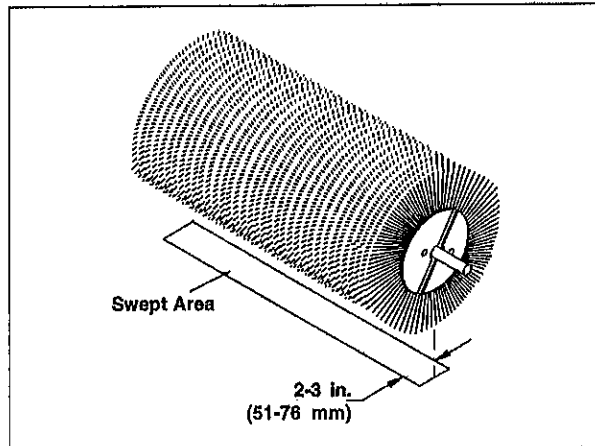

Figure 19

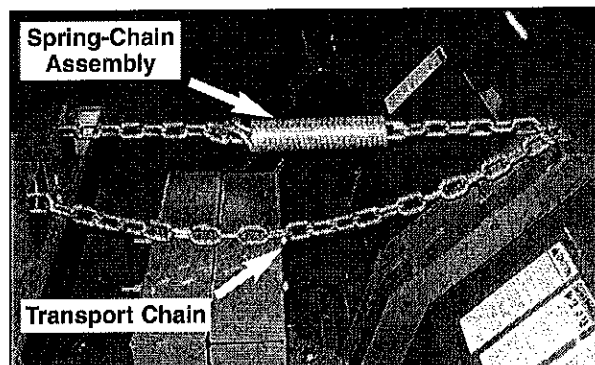

Figure 20

ADJUSTING SPRING-CHAIN ASSEMBLY

The spring-chain assembly sets the brush pattern by restricting up-and-down movement of the brush head assembly.

To adjust the brush pattern:

1. Raise the broom.
2. Increase or decrease the number of links in the spring-chain assembly between the mounting assembly chain holder and the brush head frame upright.
 - Increase the number of links to lower the brush head frame upright; or
 - Decrease the number of links to raise the brush head frame upright.
4. Adjust the transport chain.

ADJUSTING TRANSPORT CHAIN

The transport chain (Figure 20) supports the weight of the brush head assembly during transport between work sites and during adjustment of the spring-chain assembly. When sweeping, the transport chain should have 1 or 2 links of slack.

To adjust the transport chain for moving between sites:

1. Lower the broom to the ground.
2. Pull the transport chain tight and secure it in the mounting assembly chain holder.
3. Raise the broom off the ground with the hitch lift. Most of the weight of the brush head assembly should be on the transport chain, not on the spring-chain assembly.

OPERATING INSTRUCTIONS

GENERAL SAFETY

Only qualified people familiar with this manual should operate this machine. Operator should wear hard hat, safety glasses, and safety shoes. Tractor must be equipped with a Roll-Over Protective System (ROPS) and a seat belt that is used. Before beginning operation, clear work area of objects that may be picked up, thrown, or entangled. Check for ditches, holes, or other obstacles that could upset tractor or damage broom. Always turn off tractor engine, set parking brake, lower cutter to ground and allow brush core to come to a complete stop before dismantling tractor.

Safety is a primary concern in the design and manufacture of our products. Unfortunately, our efforts to provide safe equipment can be wiped out by a single careless act of an operator.

It has been said, "The best safety device is an informed, careful operator". We ask you to be that kind of an operator.

The designed and tested safety of this machine depends on it being operated within the limitations as explained in this manual. Be familiar with and follow all safety rules in the manual, on the broom and on the tractor.

The safe operation of this machine is the responsibility of the owner/operator. The operator should be familiar with the broom and tractor and all safety practices before starting operation. Read the safety rules on pages 5 thru 13.



Do not operate the PTO other than in the rated 540 RPM range. Excessive speeds can cause breakage, thrown objects, and potential injury.

PRE-OPERATION CHECKLIST

(OWNER/OPERATOR RESPONSIBILITY)

- _____ Review and follow safety rules and safety signs on pages 5 through 14.
- _____ Check that broom is properly and securely attached to tractor and that all hardware is properly installed.
- _____ Make sure driveline spring-activated locking balls operate freely and are seated firmly in tractor PTO spline groove.

- _____ Lubricate all grease fitting locations. Make sure PTO shaft slip joint is lubricated.
- _____ Check gear lube level. Check sight glass on side of gearbox.
- _____ Keep polypropylene brushes away from intense heat and flames.
- _____ Check that all shields and guards are properly installed and in good condition.
- _____ Check brush height, front to rear attitude and side to side brush height.
- _____ Place tractor PTO and transmission in neutral before starting engine.
- _____ Set tractor PTO gear select lever for 540 rpm operation.
- _____ Inspect area to be swept and remove wire, twine, branches or other objects that might be wrapped or thrown, causing injury or damage.
- _____ Check that no one enters the area of machine operation. Always work at a safe distance from people.
- _____ Know your controls and how to stop tractor, engine and PTO quickly in an emergency. READ THIS MANUAL AND THE ONE PROVIDED WITH YOUR TRACTOR.
- _____ When operating broom on any roof area, make sure guarding of roof area complies with Federal OSHA law section 1926.500 on perimeter guarding.
- _____ Check that PTO driveline shields clear the front of the broom frame and the swinging drawbar.

NOTE: This type of damage is not covered under warranty, as it is totally under the control and the responsibility of the operator.

- _____ Before sweeping, make sure storage stands are fully raised. They are designed to keep the brush off the ground when broom is dismantled or parked.

NOTE: Improper storage of broom (allowing the brushes to rest against the ground or another object) will damage the broom and is not covered under manufacturer's warranty.

OPERATING INSTRUCTIONS (continued)

OPERATION

SWEEPING

Model RMB brooms are powered from the rear PTO shaft operating in the 540 rpm speed range.

During operation, the 3 pt. lift must always be fully lowered with the draft control and position devices disengaged so that they are unable to influence the work height of the broom.

This should only be regulated by means of the height limit chains on the broom's 3 pt. mount.

Lower the 3 pt. hitch until the brush is near the ground. With the tractor engine at a **LOW** speed, engage the PTO. Slowly increase the engine speed until the desired brush speed is reached. To stop, slow the tractor to idle and then disengage the PTO.

Then slowly lower the 3 pt. hitch and broom. Shift tractor into gear and start sweeping.

NOTE: Do not allow the broom to drop violently on to the ground. Lower it slowly to allow the brush bristles to gradually start the sweeping process.

At first, begin sweeping at a slow forward speed and then shift up until the desired result and forward speed is achieved.

Optimum working speeds will usually be between 1 and 4 mph. The type of material being removed will determine the best brush rotation speed and best forward speed to use.

Remember to shift down to a lower forward gear if speed is too fast. Maintain engine speed so brush is operating at desired rpm.

This broom has been assembled so it sweeps while the tractor is moving forward. If it is preferred to sweep while moving in reverse, it is necessary to change the direction of the top gearbox. See Owner Service section of this manual.

Before sweeping, make sure the parking stands are raised. It is required to keep the brush off the ground when the broom is not attached to the tractor or if the tractor will be parked for some time.

RAISING & LOWERING

To raise or lower the broom, use tractor 3 pt. lift arms.

DO NOT use a hydraulic toplink cylinder. Always use the 3 pt. depth limit chains so that the broom operating height is the same.

NOTE: Avoid broom damage. Do not use a hydraulic toplink cylinder. Raise and lower the broom with tractor 3 pt. lift arms only.

NOTE: Avoid driveline damage. Do not run brush in raised position. Only run brush when broom is lowered.

ANGLING

Angling the broom will control the direction debris will leave the broom. Angling the brush head the same direction as the wind will also help reduce the amount of material that blows onto the operator and the area just swept.

To swing the brush head using a manual angle kit: Remove the lock pin, swing the brush head by hand to the desired angle and replace the lock pin in the nearest hole. The manual angle kit has holes for straight sweeping and 30° or 15° angle sweeping right or left.

The optional hydraulic angle kit allows use of the prime mover's remote hydraulic valves to angle the broom.

OPERATING TIPS

IMPORTANT – Avoid sweeper damage. Do not ram into piles of debris. Use a dozer blade for this type of job.

SNOW

For wet, heavy or deep snow, adjust support chains so the mounting assembly is 18-20 in. (457-508 mm) off the ground with the unit lowered.

High brush speeds and low ground speeds work best. Start at 3/4 throttle and low gear. For wet/deep snow, increase to almost full throttle. This helps keep snow from packing inside the brush hood.

In deep snow make several passes to clean the surface.

Sweeping so the wind blows from behind the sweeper or with the brush angle keeps snow from blowing onto swept areas.

DIRT & GRAVEL

To minimize dust, try to sweep on humid/overcast days or after it has rained. The addition of an optional sprinkler system will help considerably. Sweep so the wind blows the dust away from you or in the direction the brush head is angled.

If the amount of dirt is too much for the broom, use a blade to scrape the large amount of dirt away first and use the broom for final clean up. Keep forward speed low (4 mph or less).

Low brush speeds and moderate ground speeds work best. Brush speeds that are too fast tend to raise dust without increasing efficiency.

To sweep gravel, use just enough brush speed to "roll" the gravel, not throw it.

OPERATING INSTRUCTIONS (continued)

OPERATING TIPS (cont'd)

THATCH

Low brush speeds and low prime mover speeds do the best thatching job.

To prevent the brush from pulling itself into the ground, adjust the spring-chain assembly so bristle tips barely touch the grass.

If the brush pulls into the grass and stalls while sweeping, use the lift to raise the brush. Do not increase throttle to override a stall out.

Use a combination of brush speeds and ground speeds to roll up a neat windrow.

To keep thatch from blowing onto a swept area, sweep with the wind in the direction the brush is angled. (This could require sweeping in only one direction.)

TRANSPORTING



When traveling on public roads, whether at night or during the day, use accessory light and devices for adequate warnings to operators of other vehicles. Comply with all federal, state and local laws.

IMPORTANT: Always disengage the PTO driveline before raising the broom to transport position.

1. Transport Position: When the broom is in the lowered position, hook the chain in the chain link so the chain is as short as possible. This will put all the weight of the broom on the transport chain and relieve all the weight from the spring.
2. When raising the broom for transport, be sure the PTO driveline does not contact the 3 pt. lift frame of the broom.
If it is necessary to lift the unit higher to navigate rough terrain, always disconnect the PTO driveline from the tractor first.
3. Be sure to reduce tractor ground speed when turning; and, leave enough clearance so the broom does not contact obstacles such as buildings, trees or fences.
4. Select a safe ground travel speed when transporting from one area to another. When traveling on roadways, transport in such a way that faster moving vehicles may pass you safely.

5. When traveling over rough or hilly terrain, slow down and use extra care.
6. Read all the safety warnings in the front of the manual.

DO NOT OPERATE PTO DURING TRANSPORT.

PARKING STANDS

Parking stands are included as standard equipment to stabilize the broom when it is being disconnected from the tractor and is not in use. They also help protect the brushes when the broom is not in use, by taking the pressure off the brushes.

NOTE: Improper storage of broom (allowing the brushes to rest against the ground or another object) will damage the broom and is not covered under manufacturer's warranty.

NOTE: Be sure parking stand is fully raised and fastened with a locking pin before using the broom.

STORING SAFELY

- Disconnect broom PTO driveshaft from tractor.
 - Collapse PTO driveshaft as far as possible and store it to prevent ground contact. Lower the parking stands and pin in place. Lower the broom to the ground.
- NOTE:** Do not store the sweeper with weight on the brush. Weight will deform the bristles, destroying the sweeping effectiveness.
- Disconnect broom from tractor 3 pt. hitch and carefully drive tractor away from broom.
 - Remove keyhole brackets from the tractor toplink connection and store brackets with broom.
 - Storage location should be level and on a solid surface to make hitching and unhitching easy.
 - Make sure storage location is away from children, animals, or a traffic area.
 - Do not store polypropylene brushes in direct sunlight. The material can deteriorate and crumble before the bristles are worn out.
 - Keep polypropylene brush material away from intense heat or flame.

OWNER SERVICE

The information in this section is written for operators who possess basic mechanical skills. Should you need help, your dealer has trained service technicians available. For your protection, read and follow all safety information in this manual.

! WARNING! !

- ▲ **Before servicing the machine, disengage the PTO, engage the parking brake or place the transmission in "Park," shut off the power unit and remove the key. Disconnect broom PTO driveline from tractor PTO before performing any service or maintenance.**
- ▲ **Before working underneath, lower the parking stands and pin in place. Place blocks under the four parking stands if extra work height is needed. Hydraulic system leakdown and failure of mechanical or hydraulic system can cause equipment to drop.**
- ▲ **Keep all persons away from operator control area while performing adjustments, service or maintenance.**

ROUTINE MAINTENANCE

DAILY CHECKS:

1. Check that all bolts, nuts, and screws are tight.
2. Check daily the level of the gearbox oil and top up to the correct level. Check for gearbox oil leaks. It should be noted that no warranty claim can be submitted on a gearbox that has run dry. It is essential that the gearbox is kept correctly filled with gearbox oil.
3. Grease the PTO shaft and cross driveline daily.
4. Check the wear on the brush and that no material has wrapped on the brush core.
5. If broom is equipped with the optional hydraulic angle kit, check hydraulic hoses and fittings for leaks. Repair any leaks immediately. Never use your hand to check for a hydraulic leak when system is under pressure.
6. Replace any worn or damaged parts immediately. Do not use attachment with any damaged parts.

LUBRICATION INFORMATION

The chart gives the frequency of lubrication in operating hours, based on normal conditions. Severe or unusual conditions may require more frequent lubrication.

Do not let excess grease collect on or around parts, particularly when operating in sandy areas.

Use an SAE 90W gear lube in gearbox.

Use a lithium grease of NO. 2 consistency with a MOLY (molybdenum disulfide) additive for all locations. Be sure to clean fittings thoroughly before attaching grease gun. When applied according to the lubrication chart, one good pump of most guns is sufficient. Do not over grease.

Thoroughly clean the grease zerks before servicing. Dirt mixed with lubricant will rapidly wear parts and destroy bearings. Keep it clean.

LUBRICATION CHART

| <u>DESCRIPTION</u> | <u>FREQUENCY</u> |
|-----------------------------------------|------------------|
| Front PTO U-Joint | 8 Hrs. |
| Rear PTO U-Joint | 8 Hrs. |
| Gearbox – Fill to proper level | Check Daily |
| Gearbox/Broom Driveline – Both U-Joints | 8 Hrs. |
| Main Brush Head Pivot | 20 Hrs. |
| Main Brush Bearings | 20 Hrs. |
| Drive Chain | 40 Hrs. |
| (Remove and soak in motor oil) | |

Daily lubrication of the PTO slip joint is necessary. Failure to maintain proper lubrication can result in damage to U-joints, gearbox, tractor PTO and/or gearbox/broom

**OBEY SAFETY
RULES!!
ALWAYS BE
CAREFUL!!**

OWNER SERVICE (continued)

REVERSING SWEEPING DIRECTION

The Model RMB brooms are shipped with the top gearbox positioned to sweep forward while driving the tractor forward. To reverse the top gearbox rotation to sweep while backing up:

1. Remove the driveline from the top gearbox.
2. Remove the two shields that cover the top gearbox (Figure 21).
3. Remove the two bolts in the lower part of the top gearbox that hold the guide plate. Slide the guide plate away from the top gearbox.
4. Check the oil level in both gearboxes. Fill if necessary.
5. Rotate the top gearbox 180°.
6. Reinstall the guide plate (Figure 23).
7. Reconnect the driveline to the top gearbox shaft (Figure 22).
8. Reinstall the two shields over the top gearbox.



Avoid serious injury or death. Do not operate the sweeper without all shields installed.

9. Operate the unit at a low rpm while observing for excessive vibrations or other problems. Correct any problems before using the broom.

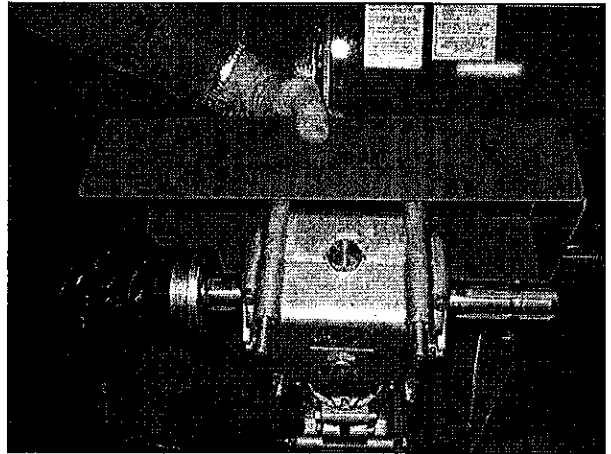

Figure 21

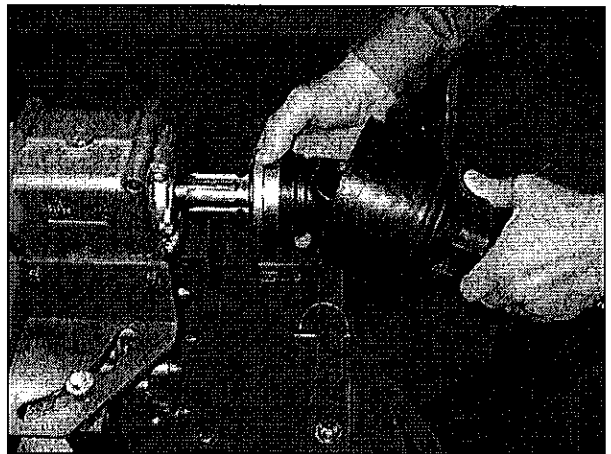

Figure 22

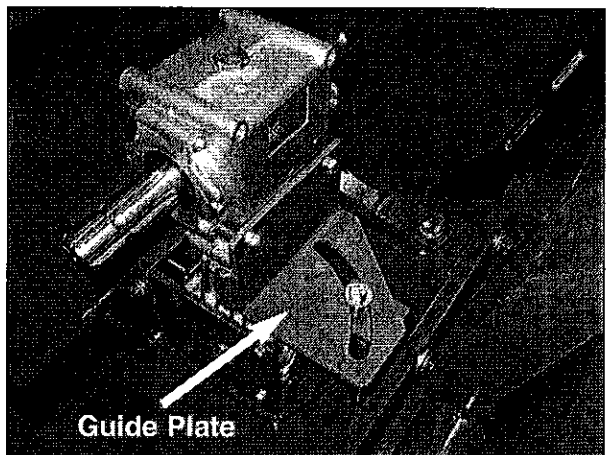

Figure 23

Continued on the next page

OWNER SERVICE (continued)

ADJUSTING DRIVE CHAIN

1. Remove the rear chain shield (Figure 24).
2. Loosen, but do not remove the four (4) bolts securing the 4 bolt bearings on both ends of the brush head assembly (Figures 24 and 25).
3. Slide the brush core away from the tractor until there is about 3/8 inch (10mm) of play in the chain.

NOTE: Avoid drive chain and sprocket damage. The drive chain must have 3/8 to 1/2 in. (10 to 13 mm) of play. Overtightening wears the chain and sprockets prematurely.

4. Tighten the four (4) bolts on the chain end of the brush head. (Right hand end, Figure 24).
5. Check the left hand end of the brush head and make sure the 4 bolt bearing is positioned the same as the right hand end (chain end). When positioned correctly, tighten the four bolts. (Figure 26)
6. Reinstall the rear chain shield.



Avoid serious injury or death. Do not operate the sweeper without all shields installed.

DRIVE CHAIN MAINTENANCE

1. Check chain adjustment – (See above instructions.)
2. Remove chain from sprockets and soak in motor oil every 40 hours of operation.
3. If chain becomes rusty or stiff, remove chain from sprockets and soak in penetrating oil; bend back and forth to restore chain flexibility. If this does not work, replace entire chain assembly.

Continued on the next page

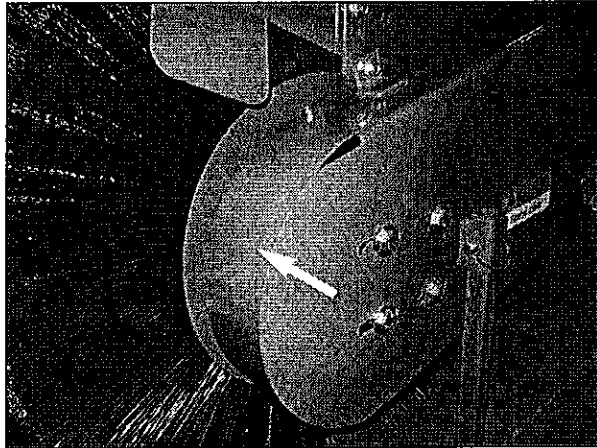

Figure 24

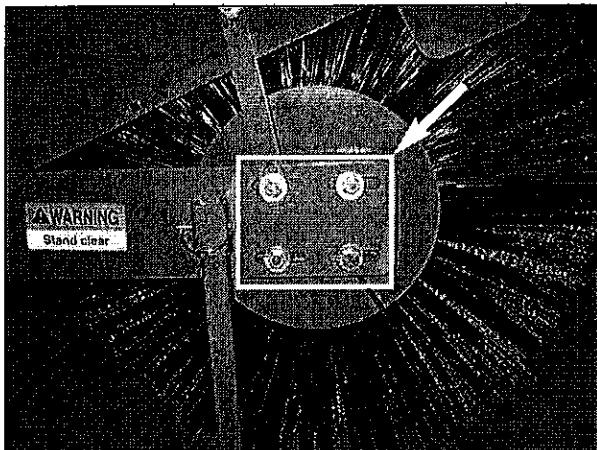

Figure 25

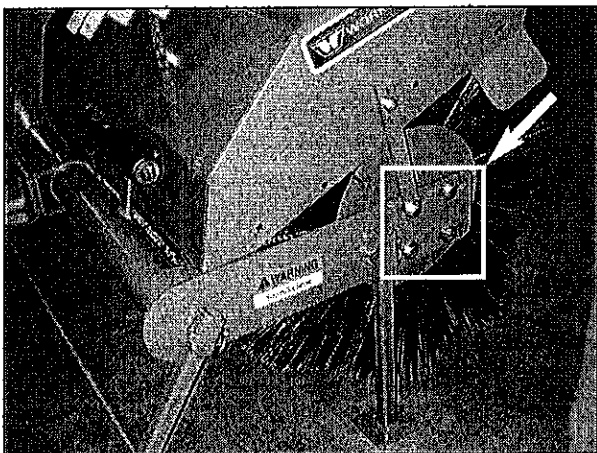

Figure 26

OWNER SERVICE (continued)

ALIGNING SPROCKETS

Keep sprockets aligned to prevent chain derailment and reduce wear on the drive chain and sprockets.

1. Remove front (Figure 27) and rear (Figure 28) chain shields from the fixed chain shield.
2. For each sprocket, measure from inside the fixed chain shield to the center of the chain (Figure 29).
3. Compare measurements.
 - If they are the same, sprockets are aligned.
 - If they are different, loosen the set screw on the small sprocket. Adjust it until it is the same distance as the large one. Tighten the set screw.
4. Reinstall chain shields.

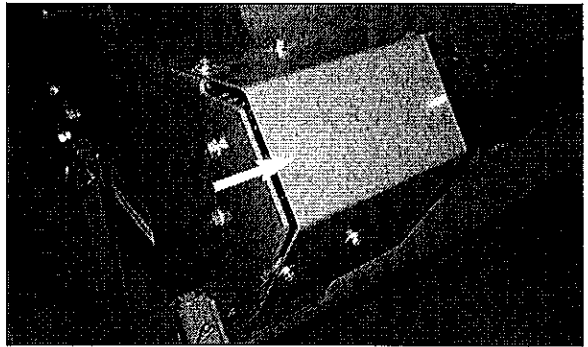

Figure 27

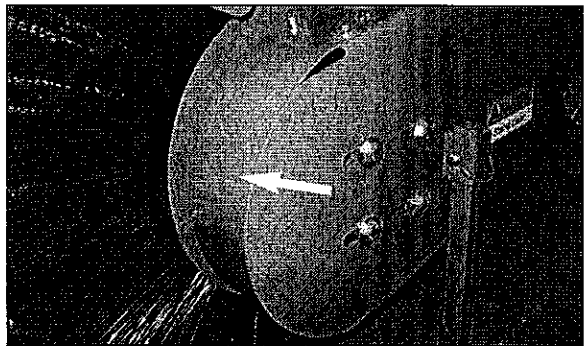

Figure 28

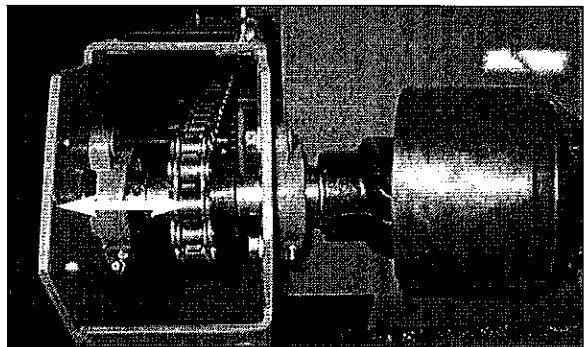

Figure 29

! WARNING! !

Avoid serious injury or death. Do not operate the sweeper without all shields installed.

BRUSH SECTION REPLACEMENT

1. Loosen 4 carriage bolts holding each bearing assembly (Figures 30 and 31).
2. Remove front (Figure 28) and rear (Figure 27) chain shields.
3. Rotate the brush to locate the master link. Remove the master link and chain.

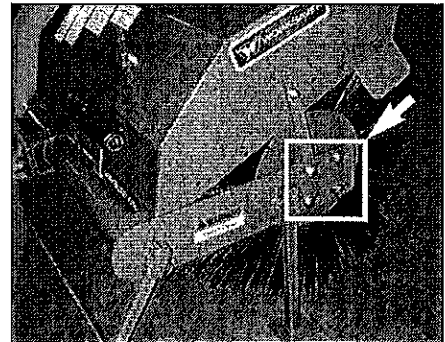

Figure 30

Continued on the next page

OWNER SERVICE (continued)

BRUSH SECTION REPLACEMENT (cont'd)

4. Pull the brush out from under the hood.
5. Stand the brush securely on blocks.
6. Remove retainer plate halves (Figure 32) from one end of the brush.
7. Slide old sections off the core.
8. Slide the first, polypropylene section onto the core (Figure 33). Be sure drive pins on brush wafer (Figures 33 and 34) straddle a tube.

NOTE – Always install a polypropylene section on each end of the core – one first and one last.

NOTE – Drive pins must all angle up or angle down.

9. Install a second section with drive pins rotated 180° from those on the first section (Figure 35).
10. Continue installing sections, rotating each section 180° until the core is full.

NOTE – If the last section will take more space than is left, but more than 1/2 in. (13 mm) remains, nest the last section on the previous one. Do this by placing both sections' drive pins on one tube.

NOTE – With new brushes, bristles may bend into the chain. Trim them to prevent chain derailment.

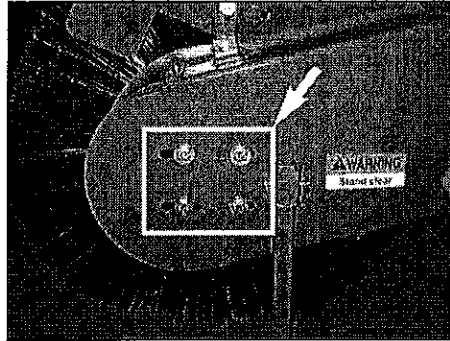

Figure 31

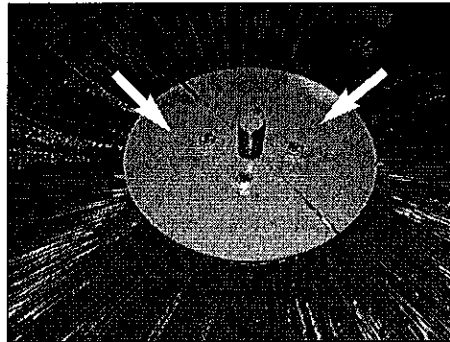

Figure 32

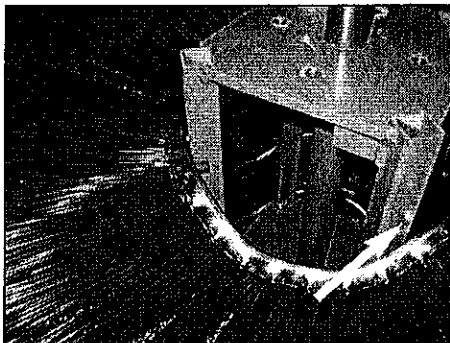

Figure 33

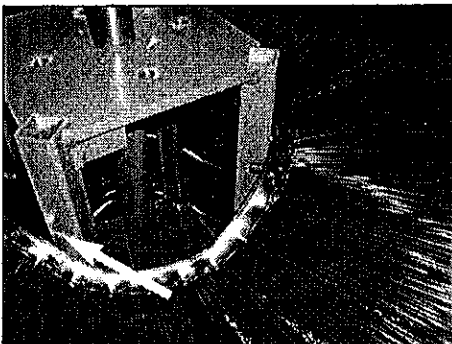

Figure 35

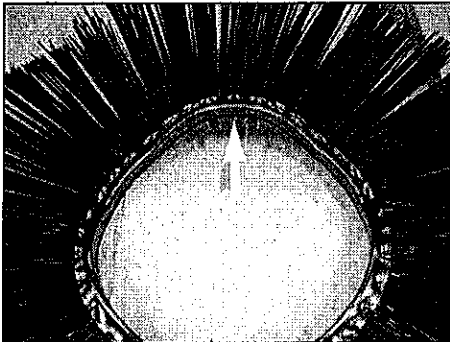

Figure 34

Continued on the next page

OWNER SERVICE (continued)

GEARBOXES

To check gearbox lubricant level, stop the power to the broom and then look at the sight glass plug in the side of each gearbox. Wipe each sight glass plug clean for best visibility.

If oil can be seen, the gearbox is full. If not, add multi-purpose 90-weight gear oil.

TO ADD LUBRICANT – TOP GEARBOX

1. Remove the two shields covering the top gearbox. (Figure 36)
2. Remove the brass hex plug in the top of the gearbox.
3. Pour multipurpose 90-weight gear lubricant into the top hole until the lubricant level is visible in the side sight glass.
4. Replace the top brass plug and the two shields.

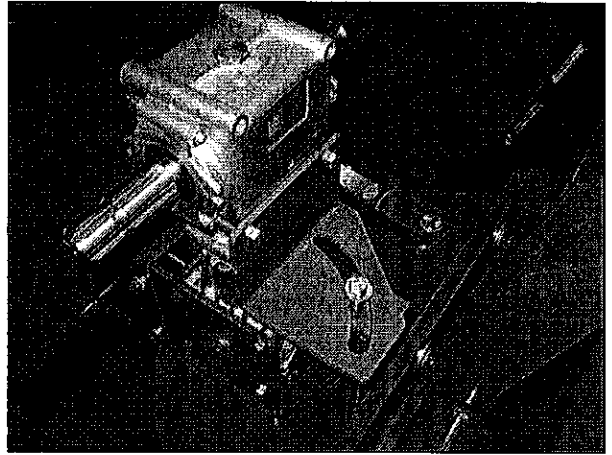

Figure 36

TO ADD LUBRICANT – LOWER GEARBOX

1. Remove the sight glass plug with a 22mm socket.
2. Using a funnel with a flexible spout, pour multipurpose 90-weight gear lubricant into the side hole until it starts to run out. (Figure 37)
3. Quickly, replace the sight glass plug.

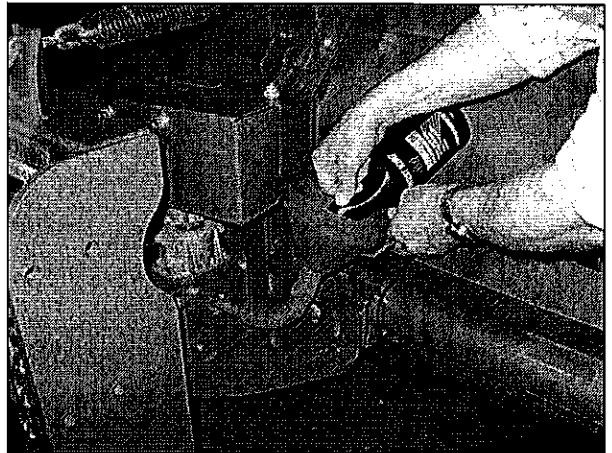

Figure 37

TROUBLE-SHOOTING GUIDE

| PROBLEM | POSSIBLE CAUSE | POSSIBLE REMEDY |
|------------------------------------------------------------|--------------------------------------------------------------|-----------------------------------------------------------------------------------------------|
| Brush rotates wrong direction. | 1. Wrong shaft connected on top gearbox. | Rotate gearbox – see Maintenance. |
| Brush head assembly “bounces” during sweeping. | 1. Spring-chain assembly needs adjustment. | Adjust spring-chain assembly (see Maintenance: Adjusting Spring-Chain Assembly.) |
| | 2. Ground speed too fast and/or brush speed too slow. | Find correct combination of ground and brush speeds. |
| | 3. Core is bent. | Replace core. |
| Brush slows or seems to be under heavy load when sweeping. | 1. Brush pattern too wide. | Adjust brush pattern to 2-3 inches (51-76mm) wide – see Maintenance: Adjusting Brush Pattern. |
| | 2. Travel speed too fast. | Travel no more than 5 mph (8 kph) while sweeping (2-3 mph recommended). |
| | 3. Trying to sweep too much material at once. | Make several passes with sweeper. |
| Machine makes intermittent clicking noise. | 1. Loose parts. | Check that all nuts and bolts are properly tightened. |
| | 2. Chain damaged. | Replace damaged chain link. |
| | 3. Gearbox gear tooth damaged. | Replace damaged gearbox. |
| Excessive vibration and/or machine jumps over ground. | 1. Wrong PTO RPM. | Place PTO lever in 540 RPM position. |
| | 2. Excessive trash wrapped on rotor. | Remove trash. |
| | 3. Damaged or bent main brush core. | Replace brush core. |
| PTO vibrates. | 1. Worn universal joint. | Replace universal joint. |
| | 2. Machine lifted too high. | Lower machine and readjust tractor 3 point lift stop. |
| | 3. PTO driveline bent. | Replace PTO driveline. |
| | 4. PTO driveline hitting front of broom or swinging drawbar. | Adjust machine lift height and/or remove drawbar. |

TROUBLE-SHOOTING GUIDE (continued)

| PROBLEM | POSSIBLE CAUSE | POSSIBLE REMEDY |
|-------------------------------------------------------|-------------------------------------------------------------------------------|---------------------------------------------------------------------------------------------------------|
| Brush wears into cone shape. | 1. Sweeper is not level. | Level sweeper before each use – see Maintenance: Leveling |
| | 2. Tires on prime mover at different pressures or are different sizes. | Check tire sizes and rating – make corrections as necessary. |
| Brush wears very quickly. | 1. Brush pattern too wide. | Adjust brush pattern to 2-3 inches (51-76mm) wide – see Maintenance: Setting Brush Pattern. |
| | 2. Spring-chain assembly not adjusted correctly. | Adjust spring-chain assembly (see Maintenance: Adjusting Spring-Chain Assembly). |
| | 3. Brush speeds too high | Use slower brush speeds. |
| Brush wears unevenly. | 1. Brush head not level. | Level brush head (see Adjustments: Leveling). |
| Drive chain falls off repeatedly. | 1. Sprockets not aligned. | Align sprockets (see Maintenance: Aligning Sprockets). |
| | 2. Too little tension on drive chain. | Tighten drive chain (see Maintenance: Adjusting Drive Chain). |
| Springs on spring-chain assemblies stretching. | 1. Transport chain too loose when traveling between job sites. | Adjust according to Adjustment: Transport Chain. |
| | 2. Travel speeds too fast when sweeping. | Do not travel at speeds over 5 mph (8 kph). |
| PTO telescoping sections distorted. | 1. Overload caused by high starting and peak torques or blocking. | Engage and disengage at idle; replace parts. |
| PTO shields damaged. | 1. Shields contact components on tractor and/or sweeper. | Allow more clearance; replace parts. |
| Gearbox does not turn. | 1. Broken shaft or gear caused by high starting and peak torques or blocking. | Do not open a gearbox still under warranty; contact Worksaver for replacement parts and service policy. |

3 PT. MOUNT ASSEMBLY PARTS DRAWING

